



Your Partner In Lift Solutions.

Technical Catalogue.



Technical Catalogue





Index

- 01 ▶ **Product development**
- 1.1 Symbio
 - 1.2 Symbio large loads
 - 1.3 Optimus
 - 1.4 Genesis
 - 1.5 Hidronic
 - 1.6 Regenerative Solutions

- 02 ▶ **Finishes**
- 2.1 Cabin designs
 - 2.2 Panoramic cabin
 - 2.3 Interior finishes
 - 2.4 Doors
 - 2.5 Push buttons & displays
 - 2.6 Structures





1.1

Symbio is an electric lift with or without a machine room, capable to adapt to any shaft needs, pit and/or headroom.

Wide loads spectrum.

► Applications

- Residential building**
- Shopping centres**
- New development**
- Hotels**
- Hospitals**
- Offices**
- Bedlifts**
- High rise installations**
- High traffic**

Advantages

Available for new buildings as well as for existing shafts with reduced pit or headroom (EN81.21).

Versatile:

It isn't necessary a designated machine room area, this allows greater space utility within the building. Even though is the quintessential new development lift, it can adapt to infinity shaft dimensions. Special shafts.

Flexibility/adaptability:

Customer tailored. Extensive load range, sizes, and speeds. Robust, resistant, and trustworthy. Able to locate operation control panel within the door frame (120mm width) as well as on landing. Power supply either single-phase or three-phase.

Comfort:

It guarantees a high level of comfort and minimal noise during its travels thanks to a centred arcade sling and 2:1 roping.

Great durability:

Reduced maintenance. The equipment has a long-life expectancy and nearly non-existent repairs.

Easy installation:

Mature design plug and play. Bedplate resting on the guides to minimise space.

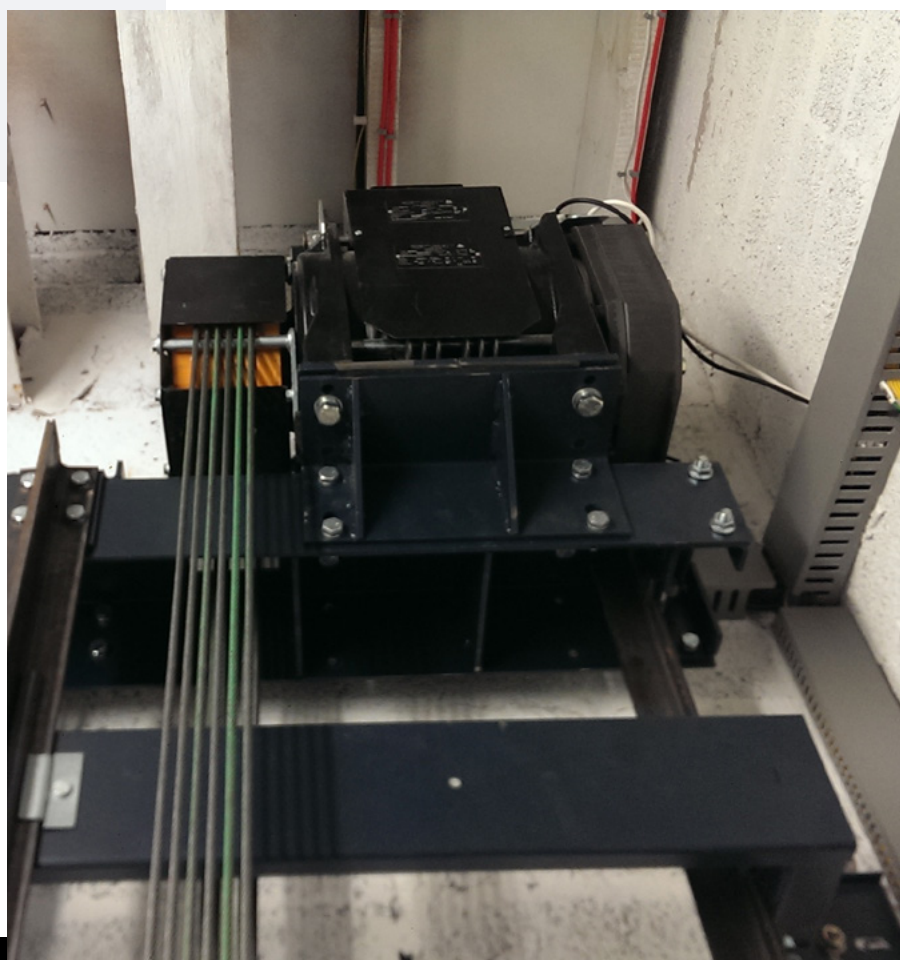

Technical characteristics

Rated load (Kg)	300 - 1600
Rated speed (m/s)	0,5 - 3,0
Machine room	CCM / SCM
Travel (m)	Up to 50
Roping	2:1
Traction ropes diameter (mm)	6,5 - 8,0

Guiding system Buffered guide shoes for greater comfort.
Always triple rollers for speed $\geq 1.6\text{m/s}$

NOTE: CEP-1600 sling cannot have buffered guide shoes.

Minimum Pit (mm)			Minimum Headroom (mm) ⁽¹⁾	
Q (Kg)	Min pit	Necessary headroom	Min headroom	Necessary pit
450	310	3.310	3015	630
630	310	3.310	3015	680
1.500	350	3.310	3335	720
1.600	420	3.500	3335	720

Entrance 0 - 180°

Door type Automatic - Semiautomatic

Panoramic car Yes

Weatherproof Yes

(1) Data for installations at 1m/s. Headroom calculated with 2005 mm car internal height.

Special solutions.

Possible configurations for irregular shafts.

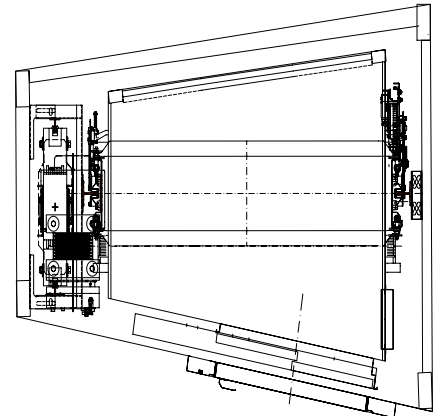

High speeds Speed up to 3m/s.

For speed $\geq 1,6\text{m/s}$, car frame with triple rollers. Maximum comfort.

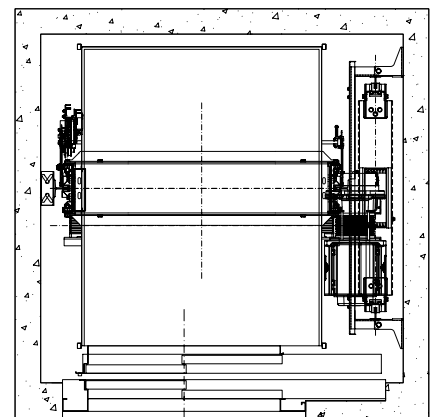
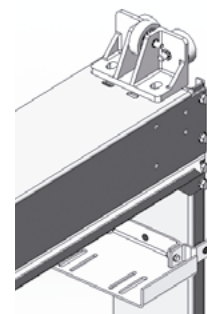

Technical characteristics Symbio HR

Rated load (Kg) 300 - 1500

Rated speed (m/s) 0,5 - 1,0

Machine room CCM / SCM

Travel (m) Up to 50

Roping 2:1

Traction ropes diameter (mm) 6,5 - 8,0

Guiding system Buffered guide shoes for greater comfort.

NOTE: CEP-1600 sling cannot have buffered guide shoes.

Minimum Pit (mm)			Minimum Headroom (mm) ⁽¹⁾	
Q (Kg)	Min pit	Necessary headroom	Min headroom	Necessary pit
450	630	2.635	2.635	630
630	680	2.635	2.635	680
1.500	720	2.655	2.655	720
1.600	720	3.200	3.200	720

Entrance 0 - 180°

Door type Automatic - Semiautomatic

Panoramic car Yes

Weatherproof Yes

Bespoke solutions

Symbio HR
Headroom 2600mm.

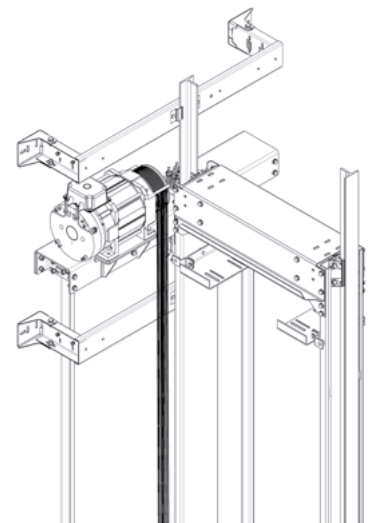

(1) Data for installations at 1m/s. Headroom calculated with 2005 mm car internal height.



Technical characteristics Symbio PF

Rated load (Kg)	-
Rated speed (m/s)	0,5 - 1,0
Machine room	CCM / SCM
Travel (m)	Up to 50
Roping	2:1
Traction ropes diameter (mm)	6,5 - 8,0

Guiding system Buffered guide shoes for greater comfort.

NOTE: CEP-1600 sling cannot have buffered guide shoes.

Minimum Pit (mm)			Minimum Headroom (mm) ⁽¹⁾	
Q (Kg)	Min pit	Necessary headroom	Min headroom	Necessary pit
450	310	3.310	3.015	625
630	310	3.310	3.015	680
1.500	410	3.310	3.335	720
1.600	410	3.500	3.335	720

Entrance 0 - 180°

Door type Automatic - Semiautomatic

Panoramic car Yes

Weatherproof Yes

Symbio PF
Shaft depth 720 mm.

Max speed 1m/s
Control panel on landing

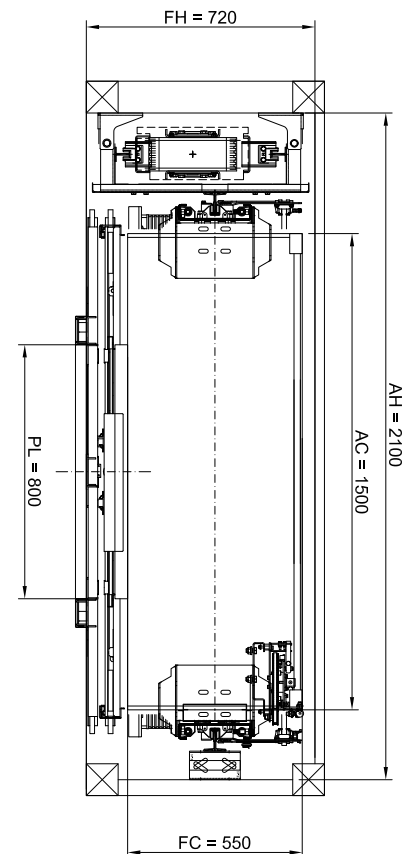

(1) Data for installations at 1m/s. Headroom calculated with 2005 mm car internal height.

Technical characteristics Symbio G

Rated load(Kg)	1800-3000
Rated speed (m/s)	0,5 - 1,0
Machine room	CCM / SCM
Travel (m)	Up to 50
Roping	2:1
Traction ropes diameter (mm)	8 - 10
Guiding system	Buffered guide shoes for greater comfort.
NOTE: CEP-1600 sling cannot have buffered guide shoes.	
Minimum pit (mm)	1.400
Minimum headroom (mm) ⁽¹⁾	3.800
Entrance	0 - 180°
Door mechanism	Automatic
Panoramic car	Yes
Weatherproof	Yes

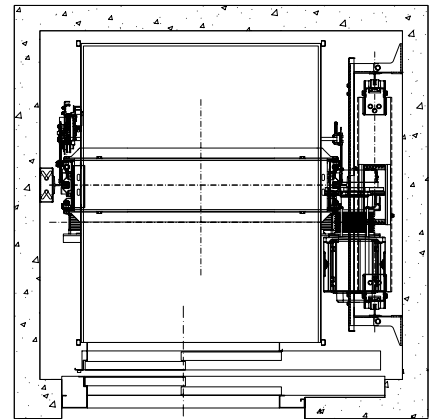

(1) Data for installations at 1m/s. Headroom calculated with 2005 mm car internal height.



1.2

Symbio machine room-less lift for larger duty loads with 4:1 roping.

► Applications

Shopping centres
Hotels
Hospitals
Offices
Larger loads
Industrial

Technical characteristics Symbio GC

Rated load (Kg) 3.200 - 5.000

Rated speed (m/s) 0,5 - 1,0

Machine room CCM / SCM

Travel (m) Up to 50

Roping 4:1

Traction ropes diameter (mm) 10

Guiding system

Buffered guide shoes for greater comfort.

Note: CEP-1600 sling cannot have cushioned slide chute.

Minimum pit (mm) 1.500

Minimum headroom (mm)⁽¹⁾ 4.000

Entrances 0 - 180°

Door mechanism Automatic

Panoramic car Yes

Weatherproof Yes

(1) Data for installations at 1m/s. headroom calculated with 2005 mm cabin minimum internal height

Advantages

Confort:

Roping 4:1 with pulleys under the car frame, providing excellent stability and great comfort.

Easy installation:

Self-supported Bedplate, and pulley beam suited to adapt to the shaft.

Adaptability:

Possibility of anti-creep for high specific loads.

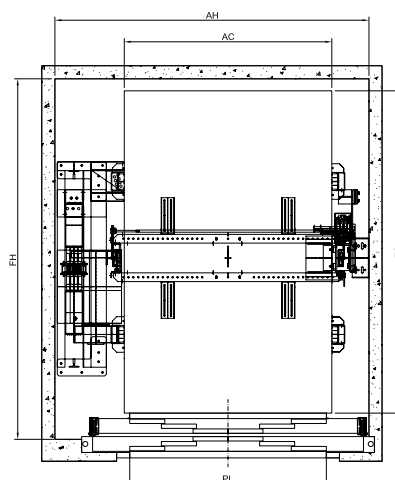



1.3

Optimus is the traction lift with or without machine room and is the most shaft-optimised lift on the market.

► Applications

Residential
Refurbishment
Existing shafts
Modernizations
Minimum shaft dimensions

Advantages

Flexibility:

Allows single, double, and triple entrance. Ideal for 90° solutions.

Single-phase:

Works on any single-phase 220 V socket.

Easy installation:

Self-supporting bed-plate easy to assemble.

Adaptability:

Possibility to design with EN 81.21 standard compensatory measures for reduced pit and hear-droom. Customised to each client.

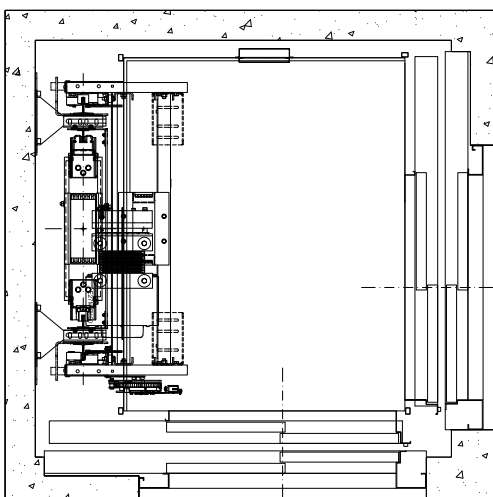
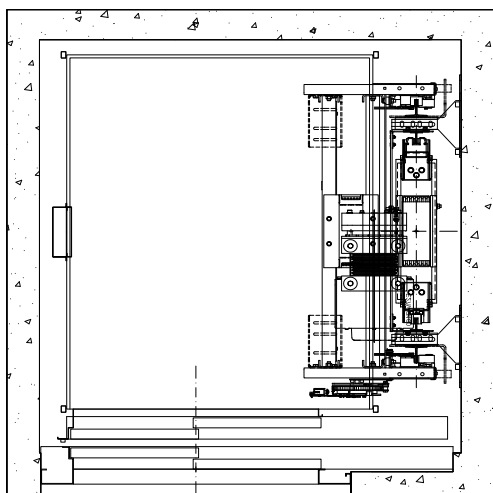

Technical characteristics Optimus

Rated load (Kg)	180 - 1.250
Rated speed (m/s)	0,5 - 1,0
Machine room	CCM / SCM
Entrances	0-90° - 180° - 270°
Roping	1:1 2:1
Traction ropes diameter (mm)	6,5 - 8,0
Guiding system	Pivoting or rollers on the safety gear side to guarantee operation.

Minimum Pit (mm)			Minimum Headroom (mm) ⁽¹⁾	
Q (Kg)	Min pit	Necessary headroom	Min headroom	Necessary pit
450	270	3.250	3.250	270
630	270	3.250	3.250	270
1.250	440	3.000	3.000	440

Travel Up to 50

Door type Automatic - Semiautomatic

Restrictive technical measure 270

Panoramic car Sf

Weatherproof Sf

Power supply Single-phase / three-phase

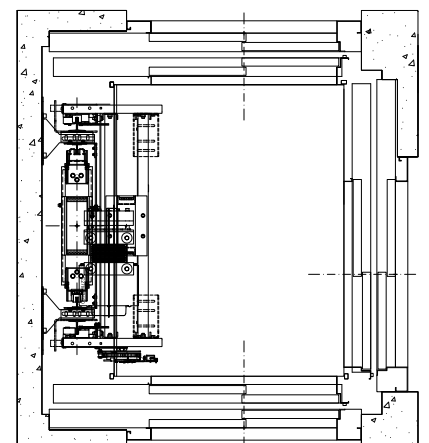

(1) Data for installations at 1m/s. Headroom calculated with 2005 mm car internal height.

Technical characteristics Optimus FHR

Rated load (Kg)	180 - 630
Rated speed (m/s)	0,5 - 1,0
Machine room	CCM / SCM
Entrances	0-90° - 180° - 270°
Roping	2:1
Traction ropes diameter (mm)	6,5
Guiding system	Pivoting or rollers on the safety geagear side to guarantee operation.
Minimum pit (mm)	265
Minimum headroom (mm) ⁽¹⁾	2.400
Travel (m)	Up to 50
Door mechanism	Automatic - Semiautomatic
Restrictive technical measure (mm)	435
Panoramic car	Yes
Weatherproof	Yes
Power supply	Single-phase / three-phase

(1) Data for installations at 1m/s. Headroom calculated with 2005 mm car internal height.

Bespoke Solutions

Restrictive technical measure 435 mm.

Q max: 630 Kg (Qt max: 1550 Kg)
 Minimum pit: 265 mm.
 Minimum headroom: 2400 mm.
 Technical measure: 435 mm.

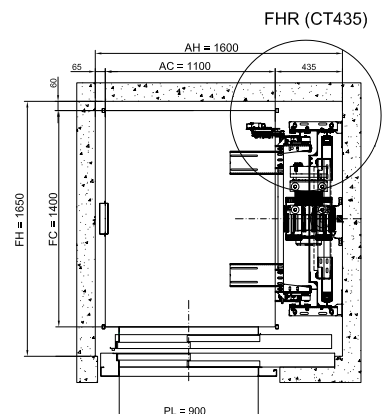

Technical characteristics Optimus GP

Rated load (Kg)	180 - 375
Rated speed (m/s)	0,5 - 1,0
Machine room	CCM / SCM
Entrances	0-90° - 180° - 270°
Roping	2:1
Traction ropes diameter (mm)	6,5
Guiding system	Pivoting or rollers
Minimum pit (mm)	320
Minimum headroom (mm) ⁽¹⁾	2.840
Travel (m)	Up to 50
Door mechanism	Automatic - Semiautomatic
Restrictive technical measure (mm)	395
Panoramic car	Yes
Weatherproof	Yes
Power supply	Single-phase / three-phase

Optimus GP
Shaft width 670mm.

Q max: 375 kg (Qt max: 1165 kg)
Min. pit: 320 mm.
Min. headroom: 2840 mm.
Restrictive technical measure: 395 mm.
Control panel on landing.

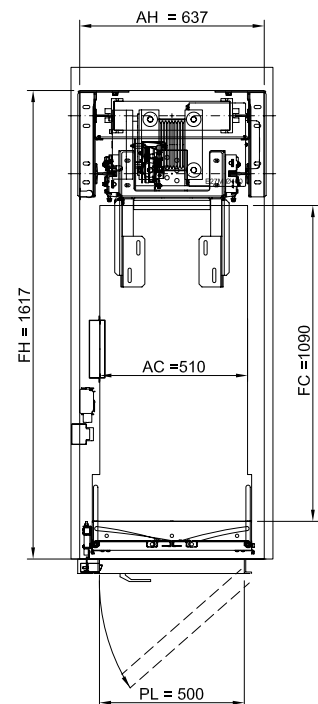

(1) Data for installations at 1m/s. Headroom calculated with 2005 mm car internal height.

Technical characteristics Optimus FHR PR 281

Rated load (Kg)	180 - 630
Rated speed (m/s)	0,5 - 1,0
Machine room	CCM / SCM
Entrances	0-90° - 180° - 270°
Roping	2:1
Traction ropes diameter (mm)	6,5
Guiding system	Pivoting or rollers
Minimum pit (mm)	320
Minimum headroom (mm) ⁽¹⁾	2.550
Travel (m)	Up to 50
Door mechanism	Automatic - Semiautomatic
Restrictive technical measure (mm)	350
Panoramic car	Yes
Weatherproof	Yes
Power supply	Single-phase / three-phase

Optimus 81.70
Entrance 90°

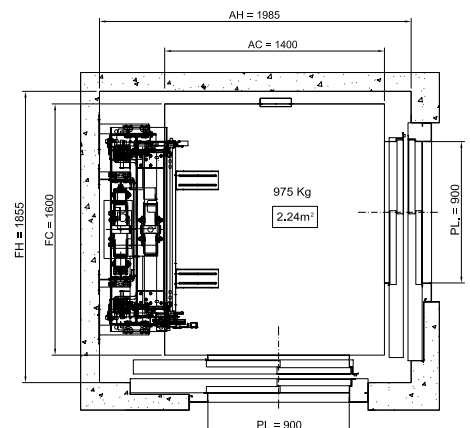

(1) Data for installations at 1m/s. Headroom calculated with 2005 mm car internal height.



1.4

Genesis is the conventional traction lift with machine room, available with geared or gearless machine.

► Applications

Refurbishment
High rise buildings
High traffic
Modernizations

Technical characteristics Genesis

Rated load (Kg)	300 - 5.000
Rated speed (m/s)	0,5 - 3,0
Machine room	CCM
Travel (m)	Up to 100
Roping	1:1 2:1
Traction ropes diameter (mm)	6,5 - 8 - 10- 12
Guiding system	guide shoes >1.6 rollers

Q (kg)	Fosos mínimos (mm)		Huidas mínimas ⁽¹⁾ (mm)	
	Foso mín.	Huida mín.	Foso mín.	Huida mín.
450	310	3.310	630	3.015
630	310	3.310	680	3.015
1.500	350	3.310	720	3.335
1.600	420	3.500	720	3.335

Entrances 0 - 90° - 180° - 270°

Door mechanism Automatic- Semiautomatic

Motors Geared - Gearless

Panoramic car Yes

Weatherproof Yes

(1) Data for Installations at 1 m/s. headroom calculated with 2055 mm cabin internal height

Bespoke Solutions

Advantages

Adaptability:

Easy to adapt to existing shafts.

Versatility:

High loads and high travel distance.

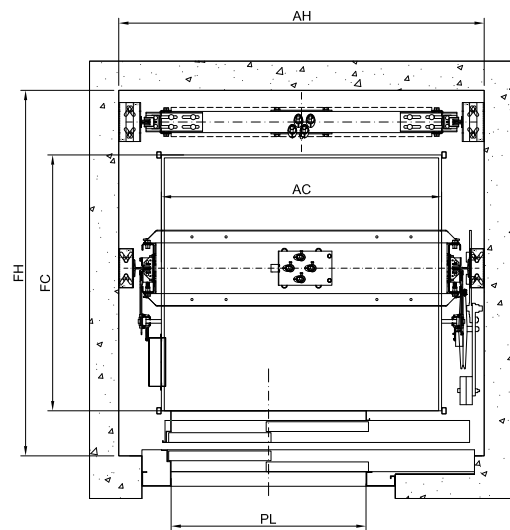

Diagonal Guides

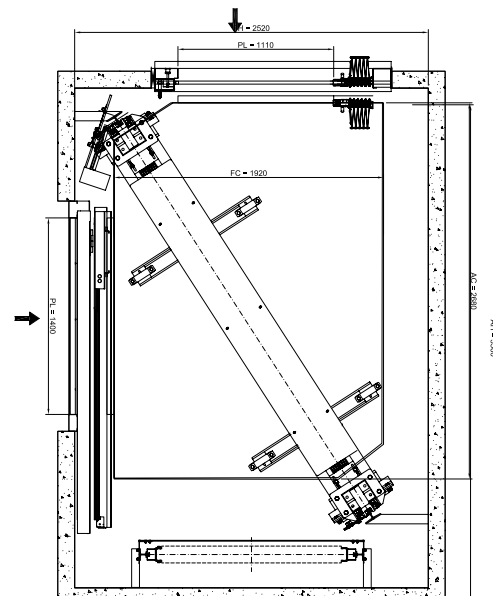



1.5

Hydronic is the ideal hydraulic lift for existing buildings, capable of adapting to any shaft type.

► Applications

**Residential
Refurbishments
Existing shafts
Modernizations
Minimum shaft dimensions**

Advantages

Versatility:

We adapt each lift to each different shaft optimizing spaces.

Reduced pit and headroom:

In existing buildings, we adapt our lifts in compliance with the Regulations for pit and headroom. (EN 81.21).

Confort:

Excellent level of confort, equivalent to a traction lift using electronic valves

Adaptability:

Easy control and maintenance.

Safety:

Automatic emergency system always active during the descent, even in the event of power failure.

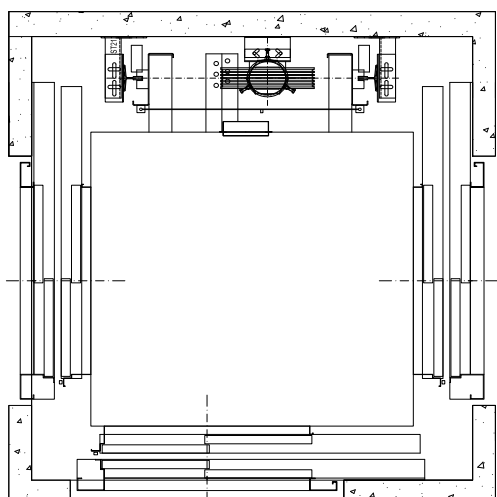
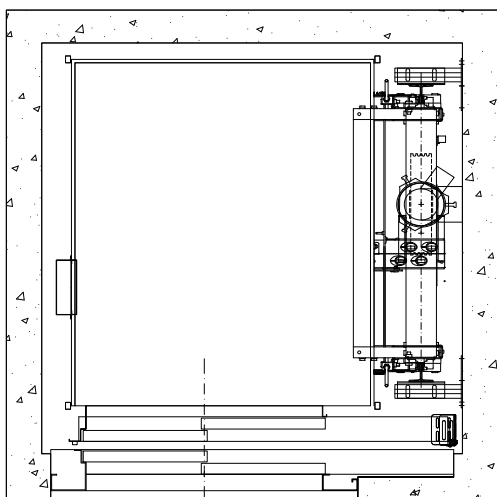

Technical characteristics

Rated load (Kg)	180 - 1.800
Rated speed (m/s)	0.3 - 0.63 (1m/s optional)
Machine room	MR / Power unit cabinet/ MRL Tank in pit
Entrances	0-90° - 180° - 270°
Roping	1:1 2:1
Traction ropes diameter (mm)	8,0 - 10,0 - 12
Guiding system	Pivoting or rollers on the safety gear side to guarantee operation



Minimum Pit (mm)			Minimum Headroom (mm) ⁽¹⁾		
Q (Kg)	Min. Pit	Necessary headroom	Q (Kg)	Min. Headroom	Necessary pit.
320	250	2.730	320	250	2.730
630	265	2.655	630	265	2.655
1.000	350	3.010	1.000	350	3.010
1.250	350	3.010	1.250	350	3.010
1.800	350	3.020	1.800	350	3.020

Travel Up to 25

Door type Automatic - Semiautomatic

Restrictive technical measure GMV - MORIS - BUCHER

Panoramic car Yes

Weatherproof Yes

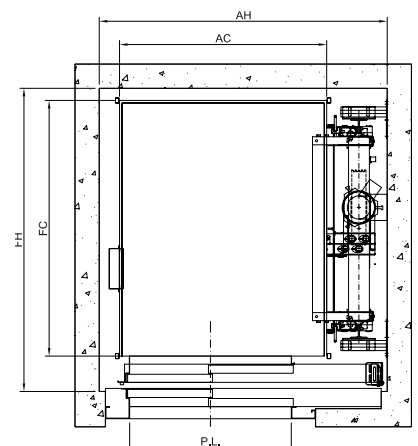

Panoramic

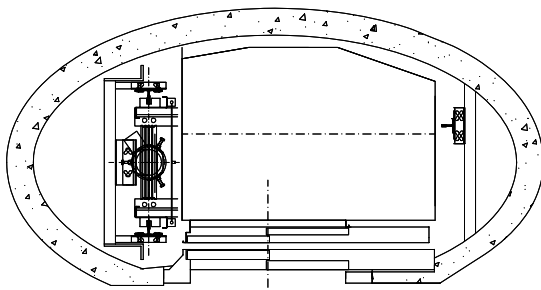

Irregular shaft

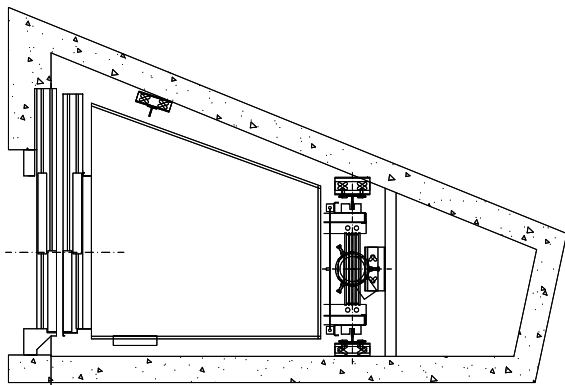

Borehole piston

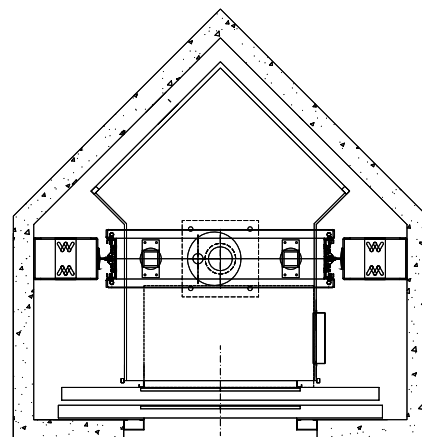
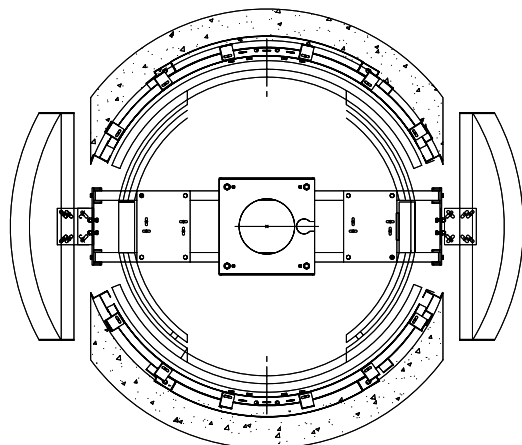

ERS 2G – Energy Recovery System

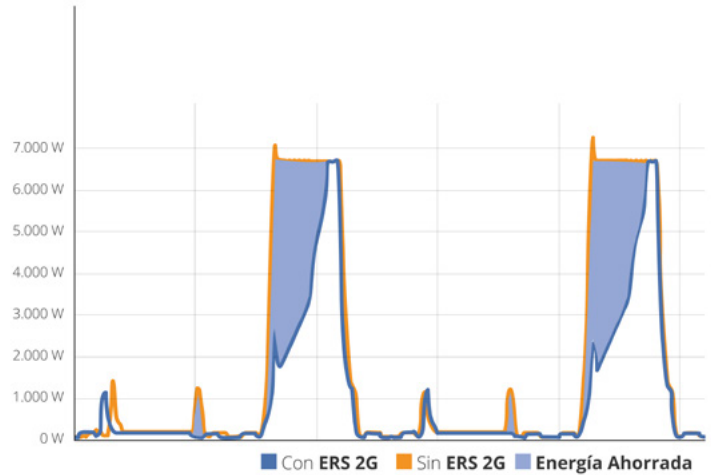

► Energy Recovery System revolutionizes elevator consumption. Regenerative solution with energy storage. It recovers the energy generated by the elevator and returns it to the elevator itself, reducing traction consumption by up to 70%. Plug and play.

P2S – plug to single-phase

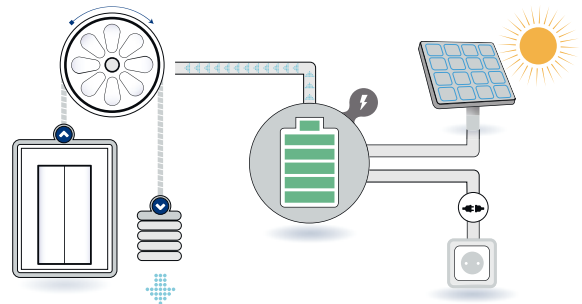

► It feeds a three-phase elevator from any single-phase power supply with a maximum consumption of 500W. It allows the use of the elevator in case of power outage and allows to transform the elevator into a solar one with only 2 panels.



Your Partner
In Lift Solutions.





2.1

Car models



101

Walls

Satin Stainless Steel

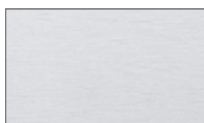

Joint

No joint between slats

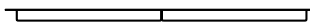

Floor

Anti-slip rubber Black





L02

Walls

F8841 White Ash



Laminate

Joint

Straight joint between slats



Floor

Anti-slip rubber Black



*M02 also available in Melamine



2.1

Car models



L03

Walls

F6307 Burnt Strand

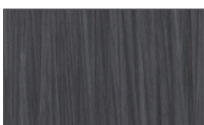

Laminate

Joint

Smooth panel

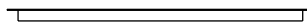

Floor

Anti-slip rubber Black

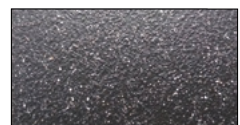

*M03 also available in Melamine



L04

Walls

F1139 Cerezo



Laminate

Joint

No joint between panels



Floor

Anti-slip rubber Black

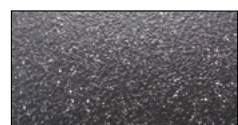

*M04 also available in Melamine



2.1

Car models



S01

Walls

White Skinplate



Joint

No joint between slats

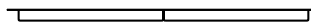

Floor

Anti-slip rubber Black

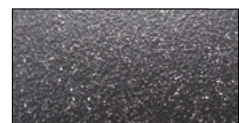



CH01

Walls

Beige RAL 1019



Painted Sheet

Joint

No joint between slats

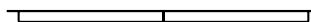

Floor

Sahara Winds

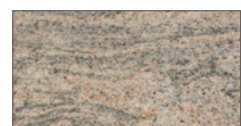



Quartz

Walls

White RAL 9003



Back painted glass

Joint

Smooth panel

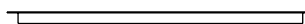

Floor

Stellar Black

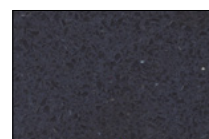



Matrix

Square Shaped Cars with different in the arrangement of the glass walls.

Models M100, M200, M300: Framed glass.

Models M100d, M200d, M300d: Frameless glass.

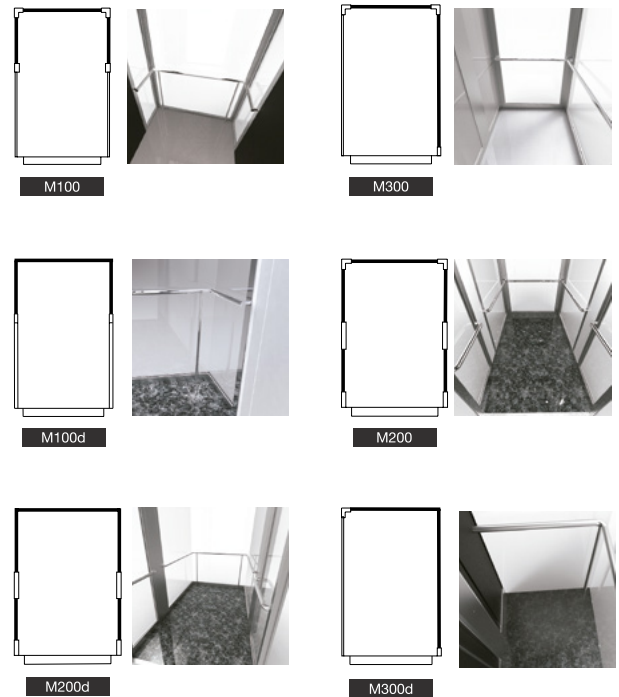

We have a multitude of shapes for panoramic cars with one or more glass walls.



Vector

Polygonal or curved cars, with or without joints between glass panels.

Models V100, V300: Framed glass

Models M100d, M300d: Frameless glass

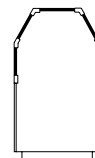

V100

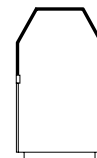
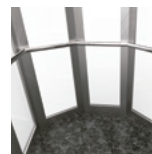

V100d

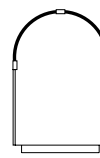

V300

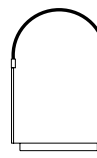
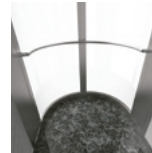

V300d



For model & load compatibility, please ask for advice.



Century

Cabinas acristaladas completamente circulares

Modelos C100: Unión entre cristales enmarcado con perfiles.

Modelos C200: Unión entre cristales sin perfiles.

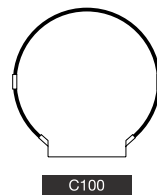

C100

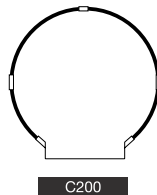

C200

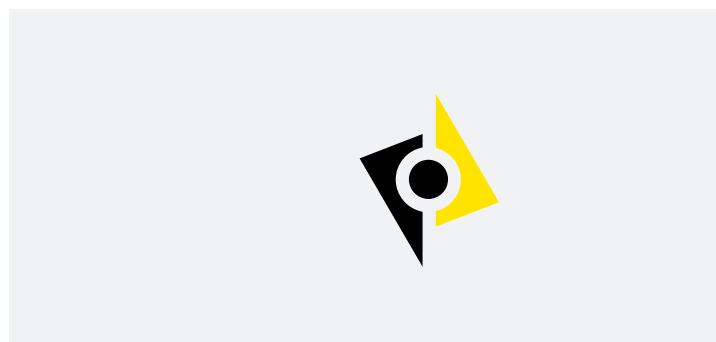

RALOE



Your expert and
trustworthy partner





2.3

Car finishes

Walls

Skinplates



White



Simil stainless steel

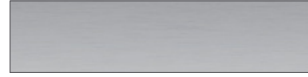

Stainless Steel



Grey



Cream

Painted Sheet



White RAL 9016



Beige RAL 1019



Pearl Light Grey RAL 9022*



Metallic grey RAL 9006

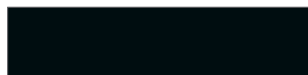

Black RAL 9005



Blue RAL 5005

* Tariff Type 2

Back painted glass (under request)

Matte (Tariff Type 3)



Oyster white RAL 1013

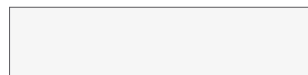

White RAL 9003*



Metallic grey RAL 9006



Black Starlight RAL 0337*



Bronze



Light Brown RAL 1236



Aluminium RAL 9007

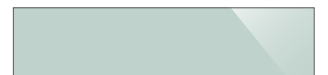

Green RAL 8615

*Pistachio green (hand painted, under request)

*Tariff Type 2

Stainless Steel

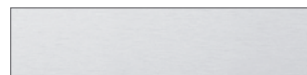

Brushed



Checks



Canvas



Leather



Linen



Polished

Available any other finish from:





Laminated (in stock)



F2274 White France



F2273 Seringa

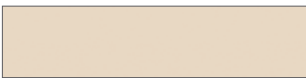

F2833 Sandstone



F8841 White Ash



F0190 Finn Beech

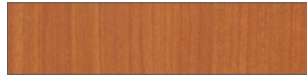

F1139 Cherry Tree



F1062 Smoked Oak



F6307 Burnt Strand*



F7927 Folkestone



F8830 Elemental Concrete

Laminated (under request)

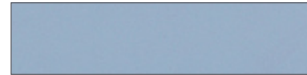

F7884 Blue



F2478 Bermuda



F1997 Ocean

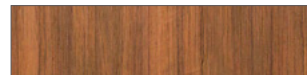

F8849 Natural Teak



F8848 Black Legno



F7837 Graphite



F8833 Elemental Graphite



F8832 Elemental Corten



F3091 Crystal White

*Tariff typo 3

* Other formicas available at <https://www.formica.com/es-es>

Colors shown may vary from the actual color depending on the computer monitor settings or the printing conditions.

Melamine

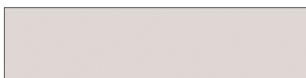

Cream

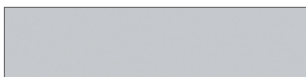

Grey



Chocolat



Blue



Cervine Pine



Beech



Cherry tree



Habana Linen



Dark Oak

Not in compliance with the standard EN 81.20

Floors

Anti-slip rubber 4,5 Kg / m²



Beige



Oak

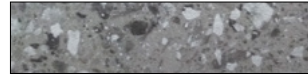

Grey granite



Blue



Sand



Grey



Grey concrete

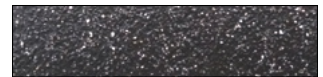

Black

Artificial Stone 49 kg / m²

Tariff Type 1



Grey Expo

Tariff Type 2

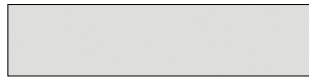

White North



Concrete Spa



Black Starlight



Royal Reef

Tariff Type 3



Merope

Natural granite 56 kg / m²

Tariff Type 1

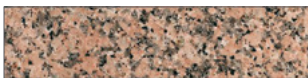

Pink Porriño



Grey Perla

Tariff Type 2



White Crystal



Grey Quintana

Tariff Type 3

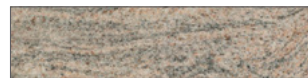

Sahara Winds

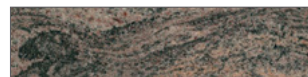

Reliquia



Black South Africa



Intense Black

Tariff Type 4



Dark Blue Labrador



Andromeda

Metallic floor



Aluminum checkerboard
6 Kg/m²



Stainless steel 12 Kg/m²



Steel durbar plate 36 Kg/m²



Ceilings

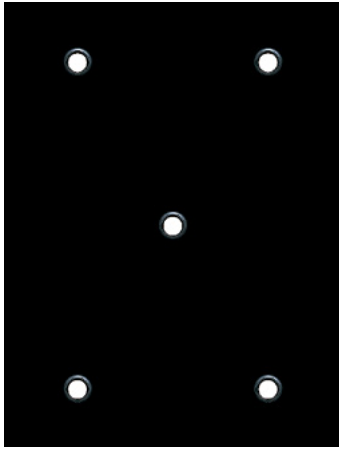

LED spots

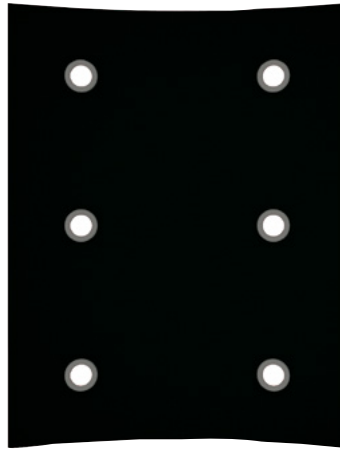

Curved LED spots

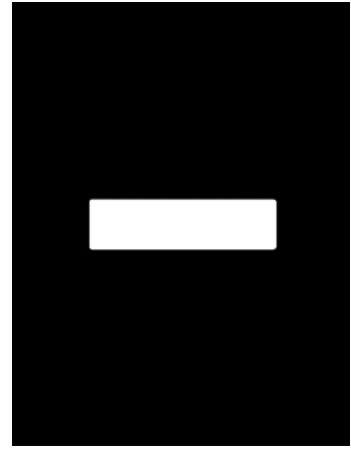

LED Strip

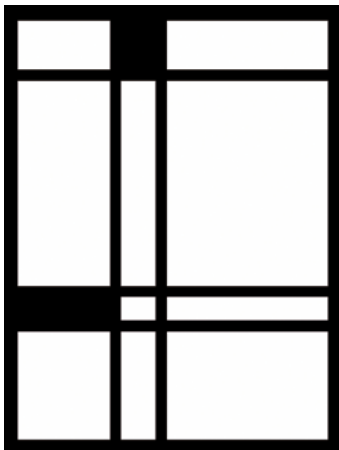

Mondrian

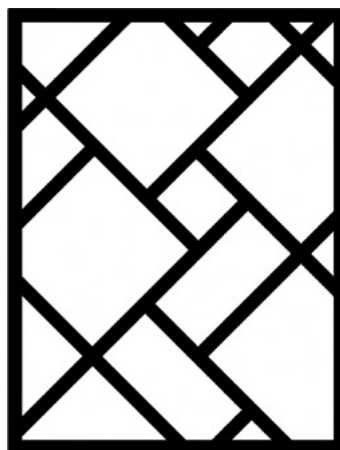

Arte

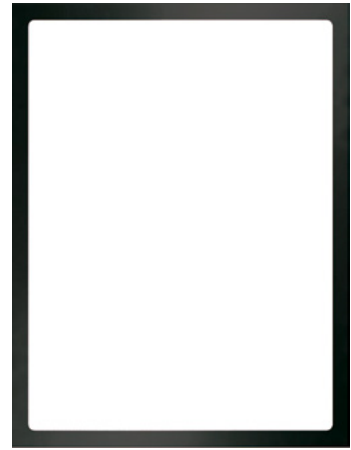

Marco

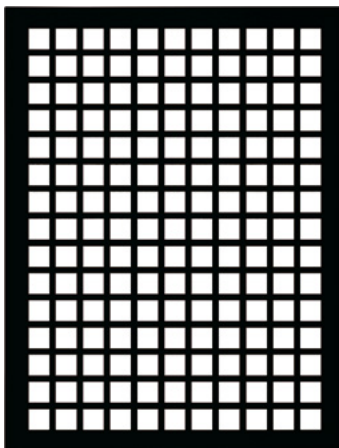

Mosaic

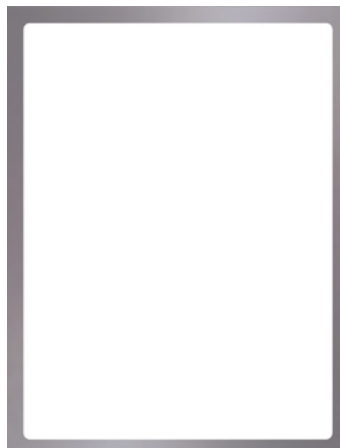

Tinted glass



All ceilings can be selected in white, black and stainless steel finishes.

Mirror

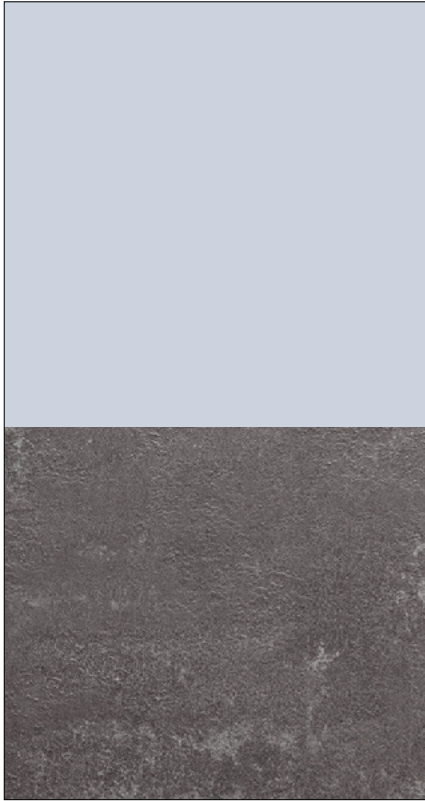

1/2 Height

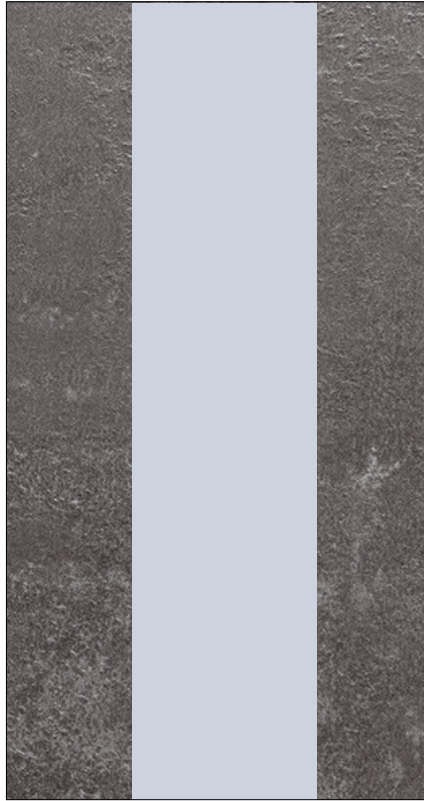

Slat mirror

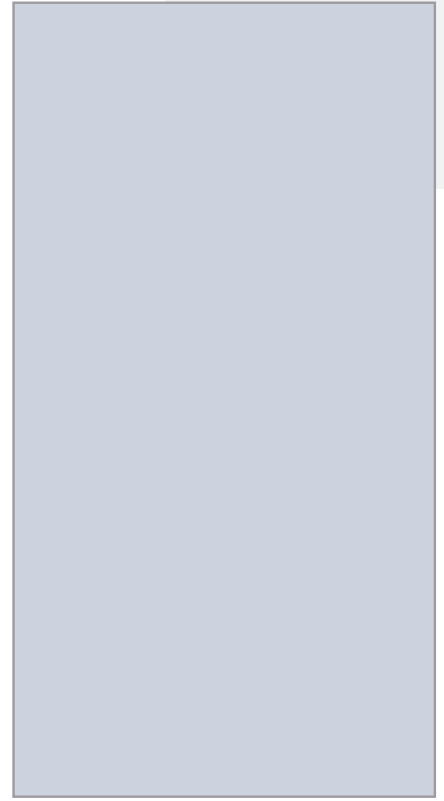

Full mirror

Handrail

STANDARD EN 81-20



- 1. Rectangular stainless steel.
- 2. Rectangular skinplate.
- 3. Straight tubular polished St. Steel.
- 4. Curved tubular satin St. Steel.
- 5. Curved tubular polished St. Steel.
- 6. Curved tubular painted black.

Automatic door



Primed
Stainless steel



Big vision panel



Folding Bus door big vision panel



Full glass stainless steel frame

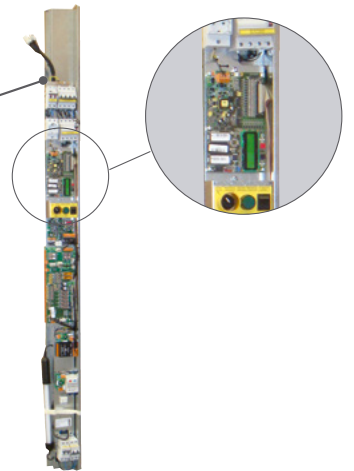

► Control panel in door frame.

Available for Carlos Silva,
Elec Megom, Sprinte and
New Lift.



Semi-automatic doors



Standard Vision panel



Big vision panel

Door finishes

► Embossed Epoxy

STANDARD

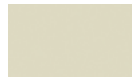

RAL 7032

OTHERS

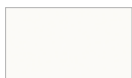

RAL 9016

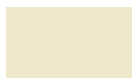

RAL 1015



RAL 9006



RAL 7004



RAL 1018



RAL 1019



RAL 6021



RAL 1034



RAL 3020



RAL 5012



RAL 8023



RAL 7010



RAL 7012



RAL 3004



RAL 6005



RAL 5011



RAL 9005

► Smooth Stainless steel

STANDARD



AISI 441 2B/BA



AISI 304 2B



AISI 316 2B



AISI 441 2B



AISI 304 2B



AISI 304 2B



AISI 316 2B



AISI 316 4N

DECORATIVE



AISI 304 BA



AISI 304 BA



AISI 316 BA

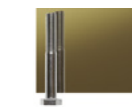

AISI 304 BA



AISI 304 BA



AISI 304 BA



AISI 304 BA

► Patterned Stainless steel



AISI 441 BA⁽¹⁾



AISI 304 BA



AISI 304 BA



AISI 316 BA⁽¹⁾

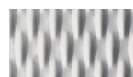

AISI 441 BA⁽¹⁾

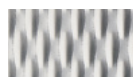

ISI 304 BA



AISI 304 BA



AISI 304 BA

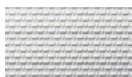

AISI 441 BA⁽¹⁾

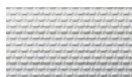

AISI 304 BA

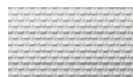

AISI 304 BA

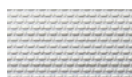

AISI 316 BA⁽¹⁾

Available any other finish from:



Car Operating panels



Epsilon

Glass panel

Standard
Height 1960 mm
Standard only for lifts. For Home Lift,
supplied without display.



Handrail Type (EN81.70)



Landing operating panels



With engraving on steel plate



With transparent window plate



Surface mounted



Surface mounted



With Display

Push buttons



Bas 120



Bas 120 Black



RT42



US91-EN



US95-EN



AT33RM



US90 Jumbo



US95 Jumbo



B3 (Arkel)



B3 Black (Arkel)



V2-P (Arkel)

Indicators



SURFACE mounted



DIRECTIONAL ARROWS



RETRO

Displays

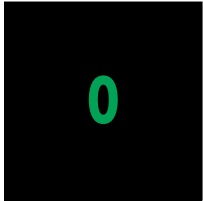

TFT 2,8"
CARLOS SILVA

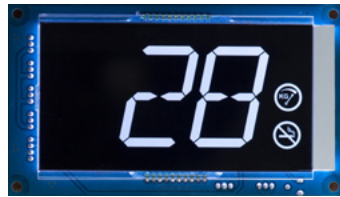

LCD10555
ARKEL



TFT 2385
LESTER



LCDA
ARKEL



EAZ-TFT-45 2,8"
NEWLIFT



TFT 5,6"
CARLOS SILVA



TFT 4,3" Clearview
DIGITAL ADVANCE



LIFTMEDIA
ARKEL



TFT 2381
LESTER



EAZ-TFT-110 5"
EAZ-TFT-210 10,3"
NEWLIFT



7"
CARLOS SILVA



10"
CARLOS SILVA



Your Partner
In Lift Solutions.



2.6

Structures

The structures for Passenger Lift and Home Lift give us flexibility, by eliminating architectural barriers and bringing solutions for the total accessibility.

STRUCTURES

► Colors



RAL 9002



RAL 3004



RAL 1015



RAL 6005



RAL 7032



RAL 5003



RAL 7001



RAL 9005



RAL 8003



OXIRON

Advantages

The assembly time is reduced by over 60% compared to an installation with traditional construction system, with a clean, fast, and quiet product.

Absolutely respectful with the environment, both in the assembly process and industrial development.

Ease of assembly, makes this product highly simple to operate complying with the higher safety standards.



Characteristics

Multi-purpose technical solution for every building, they can be adapted to the different constructive requirements. TC series are designed to be integrated in the existing building and its environment.

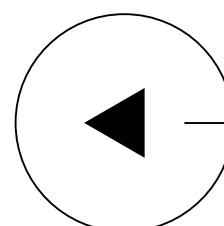



Ceiling (metal sheet or glass)



Roof over door (metal sheet or glass)



Handrail



Ventilation



Types of enclosure



Transparent glass



Frosted glass



Total glass



Blind sheet



Mesh sheet



RALOE



Headquarters and offices

HEADQUARTERS /VALENCIA BRANCH

C/ Coeters, 27

46980 Paterna

+34 961 345 350

comercial@raloe.com

RALOE EXPORT

+34 961 345 379

export@raloe.com

MADRID BRANCH

C/ Arboleda 18, Nave L

28031 Madrid

+34 913 013 720

RALOE DEUTSCHLAND GmbH

Carl-Zeiss-Ring 14

85737 Ismaning

+49 (0) 89 306 44 765-0

BARCELONA BRANCH

C/ Montserrat Roig, 56

08908 L'Hospitalet

+34 932 643 910

RALOE UK LTD

Office S23, The Nucleus

Brunel Way, Dartford

Kent DA1 5GA

+44 (0) 759464 9122

FRANCE PARÍS BRANCH

París

+33 615 587 392

WWW.RALOE.COM



